

Article number: 20251M420AK

Description: E+G Setting bolt GN 251-M4-20-AK
with nut

Measures

Type AK



Type BK

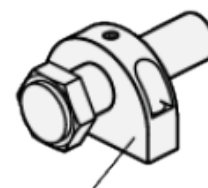
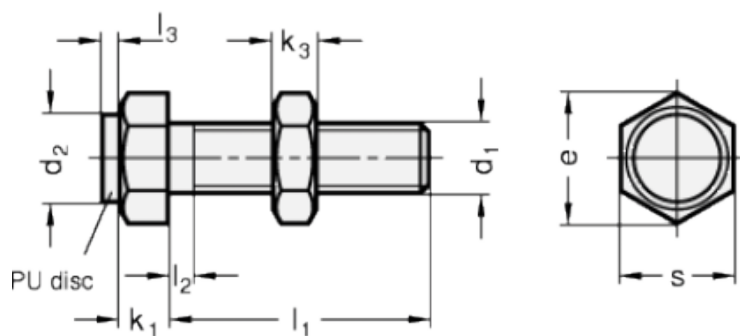

Mounting block GN 412.1

d	= M4	s = 7
e	= 8.1	
K	= -	
k1	= 2.8	
k2	= 3.2	
l1	= 20	
l2 max.	= 2.1	
l3	= -	